



DuoRacer Series

—MPPT Dual Battery Solar Charge Controller

User Manual



Models:

DR1106N-DDB/DDS

DR1206N-DDB/DDS

DR2106N-DDB/DDS DR2206N-DDB/DDS

DR3106N-DDB/DDS DR3206N-DDB/DDS

DR2210N-DDB/DDS DR3210N-DDB/DDS

Important Safety Instructions

Please reserve this manual for future review.

This manual contains all the instructions of safety, installation, and operation for DuoRacer series MPPT Dual Battery Solar Charge Controller (referred to as the controller in this manual).

- Read all the instructions and warnings carefully before installation.
- No user serviceable component inside the controller. Do NOT disassemble or attempt to repair the controller.
- Avoid direct sunlight, high temperature, and do NOT install the controller at locations where water can get in.
- Install the controller at well-ventilated places, the controller's heat sink may become very hot during the system operation.
- Appropriated external fuses or breaker are suggested.
- Please cut off all connections of the PV array, fuses or breakers which close to the battery before the controller installation and adjustment.
- Power connections must remain tight to avoid excessive overheating from the loose connection.

CONTENTS

1. Overview	1
1.1 Information & Features.....	1
1.2 Name definition	2
1.3 Structure.....	2
1.4 Starter battery BATT2 Instruction	3
1.5 AES Signal Output Port Instruction	4
1.6 Accessories	5
2. Installation	7
2.1 Warning.....	7
2.2 PV Array Requirements.....	7
2.3 Wire Size.....	10
2.4 Mounting	11
3. Display units	15
3.1 DuoRacerDisplay Basic (DDB).....	15
3.2 DuoRacerDisplay Standard (DDS).....	17
4. Protections, Troubleshooting & Maintenance	23
4.1 Protections	23
4.2 Troubleshooting	23
4.3 Maintenance.....	24
5. Specifications	26
Annex I Mechanical Dimension Diagram	28

1. Overview

1.1 Information & Features

DuoRacer MPPT charge controller is made for charging two batteries (shown as BATT1 and BATT2 below) at the same time in a solar system. This controller supports multiple life battery (BATT1) types, including Sealed, Gel, Flooded, LiFePO₄, and Li-NiCoMn, which is suitable for RV, Camper, Boat, and so on. The device recognizes the start battery (BATT2) system voltage automatically, and trickle charges the battery when the conditions are satisfied.

The controller adopts the advanced MPPT control algorithm, which will minimize the maximum power point loss rate and loss time, also fast track the maximum power point (MPP) of the PV array, and obtain the maximum energy from solar array under any conditions. The energy utilization in the MPPT solar system is increased by 20-30% compared with PWM charging method.

When there is no manual operation for a long time, and the charging conditions cannot be reached, the controller will turn to low-power mode, which reduces the loss and battery power waste to enhance the products life. The system parameters are shown and set by LED/LCD or the MT11 remote meter (Accessory).

The AES control signal of the car refrigerator is built in the controller, which will supply the surplus solar power to the refrigerator to avoid energy waste. The controller comes with IP33 protection level, which is waterproof and dustproof. Multiple protection features, including battery overcharge protection, over discharge protection, and reverse connection protection of the PV and battery, which effectively ensure the solar system safety, stability, and lifetime.

Features:

- Maximum Power Point Tracking technology with ultra-fast tracking speed and the tracking efficiency is no less than 99.5% guaranteed
- Advanced MPPT control algorithm to minimize the MPPT loss rate and lost time
- The wider range of the MPP operation voltage to improve the PV module utilization
- Auto control function of charging power & charging current limitation (BATT1)
- High quality and low failure rate components of ST, TI and Infineon to ensure the product life
- Digital circuit control of adaptive three-stage charging mode to enhance BATT1 life.
- BATT1 type can be set via LED/LCD.
- Product runs into the low-power mode when there is no manual operation for a long time, and charging conditions are not satisfied (PV < 5V).
- 100% charging and discharging in operation environmental temperature range.

- LED and LCD display units selectable.
- AES control signal for car refrigerator to avoid energy waste.
- Standard Modbus protocol, and RS485 (5V/200mA) communication port for the customer to expand the application area.

①Life battery (BATT1) is the energy storage battery for powering the household loads in the off-grid system, which supports Sealed, Gel, Flooded, LiFePO4, and Li-NiCoMn batteries (the controller can NOT recognize the system voltage automatically).

②Start battery (BATT2) is the energy storage battery which usually built in the vehicle for powering the system such as RV and Boat, and only supports lead-acid battery (the controller will recognize the system voltage automatically).

NOTE: the BATT1 and BATT2 must be at the same voltage level.

1.2 Name definition

DR 3 2 10 N - DDB

- Display Unit: DDB(DuoRacer Display Basic)
DDS(DuoRacer Display Standard)
- Common Negative System
- Max. PV open circuit voltage:06-60V,10-100V
- BATT1 System Voltage:1-12VDC,2-12/24VDC
- BATT1 Charge Current:1-10A,2-20A,3-30A
- DuoRacer Series

1.3 Structure

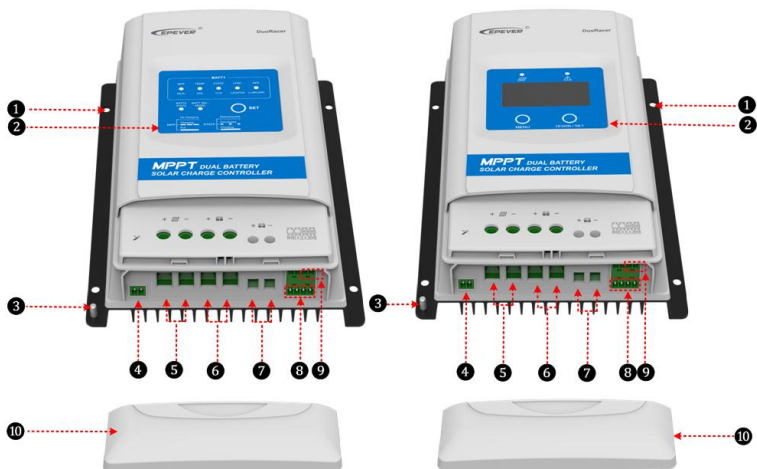

①	Mounting hole sizeΦ5mm	⑥	BATT1 terminals
②	LCD(Refer to chapter 3)	⑦	BATT2 terminals
③	Grounding Terminal	⑧	RS485 Communication port ⁽²⁾
④	Remote temperature sensor ⁽¹⁾ port	⑨	AES (signal) output port ⁽²⁾
⑤	PV terminals	⑩	Terminal protection cover

(1)The controller is charging the BATT1 as default (25°C) without temperature compensation function when it's not connected to the remote temperature sensor, or the temperature sensor is damaged. The temperature compensation is ONLY designed for the lead-acid battery, for lithium battery, there is no temperature compensation.

(2)AES port which output is 12V/200mA and RS485 Port which output is 5V/200mA are independent of DR1106/2106/3106N models, the AES port output voltage is the battery voltage. The above two ports of DR1206/2206/3206/2210/3210N models share the power of 5VDC/Max. 200mA

also the AES signal port is designed for AES supporting car refrigerator, It is required for internal power switching device.

1.4 Starter battery BATT2 Instruction

1)Working principle of starter battery

The controller trickle charges the BATT2 at 1A constant current. When the voltage reaches the “Full voltage” during the BATT2 charging process, the controller will stop charging and exit from constant voltage charging mode.

2) Voltage control parameters of starter battery

Item	Default	Modify range
Full voltage	13.8V/12V; 27.6V/24V	9~17V(24V×2)
Charge return voltage	13V/12V; 26V/24V	9~17V(24V×2)



CAUTION: Please follow the logic of Full Voltage > Return Voltage when modifying the voltage point.

3) Start Charging Conditions



CAUTION: BATT2 ONLY supports lead-acid battery type, before starting the BATT2 charging, please connect the BATT1 first.

Condition1: BATT2 start charging when BATT1 reach the float charging stage and the BATT2 voltage is lower than the “Charging Return Voltage”.

Condition 2:BATT2 start charging when the batteries total charging current is higher than 3A and the BATT2 voltage is lower than the “Charging Return Voltage”.

4) Stop Charging Conditions

Condition 1:BATT2 stops charging when the PV voltage is no lighter 2V than BATT1.

Condition 2:BATT2 stops charging when BATT1 is not in float charging stage and the total charging current for the battery is less than 2.5A.

Condition 3: BATT2 stops charging when BATT2 reaches the “Full Voltage”.



CAUTION: After the BATT2 charging is turned off, it will be recharged only when the start charging conditions are satisfied again.

5) Starter Battery (BATT2) Charging indication

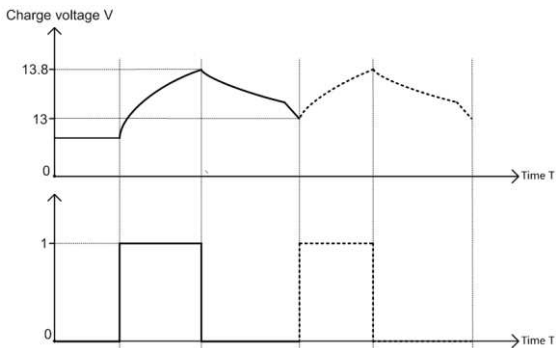

1.5 AES Signal Output Port Instruction

1) AES port of DR1106/2106/3106N-DDB/DDS

The AES port and the RS485 port are independent, the AES port output 12V/200mA and the voltage is the battery voltage. Connect the refrigerator, refer to the below picture.

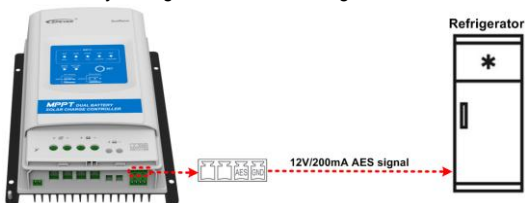

2) AES signal port of DR1206/2206/3206/2210/3210N-DDB/DDS

The AES signal port and RS485 port share the power of 5VDC/Max.200mA., connect the accessories when connect the refrigerator, refer to the below picture.

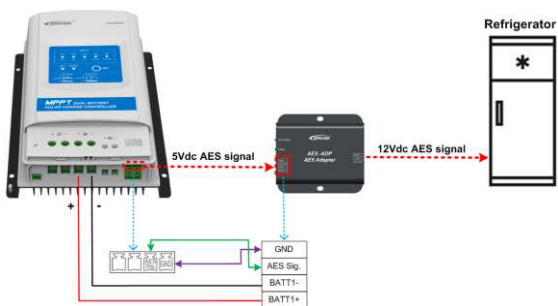

NOTE:The AES signal port and RS485 port share the power of 5VDC/Max.200mA. The MT11 power consumption is 13mA when it is ON, and 4mA when it's off.

3) AES port working principle

- The AES signal turns on after the BATT1 voltage reaches the boost charging voltage or equalize charging voltage for 5 mins.
- The controller will check if the BATT1 voltage is lower than the boost charging voltage or equalize charging voltage every 5 mins (This value is the judgement delay time for turning off the AES signal which can be set via PC software, default as 5 mins, ranging from 0 to 999 mins) , the AES signal control will be turned off if it meets the conditions for 5 times.

1.6 Accessories

Accessories(included):



Local Temperature Sensor (Model:RT-MF58R47K3.81A)



AES signal terminal(Model:3.81-2P)

The 2P cable is recommended for connecting the AES signal port of the car refrigerator.

Accessories(optional):

1) Remote Meter(Model: MT11)



MT11 can display various operating data and fault information of the system. The information can be displayed on a backlit LCD screen, the buttons are easy-to-operate, and the numeric display is readable. Standard version is for surface mounting, and optional version is for wall mounting. (Standard version includes the communication cable)

2) Remote temperature sensor(Model:RTS300R47K3.81A)



Acquisition of battery temperature for undertaking temperature compensation of control parameters, the standard length of the cable is 3m (Length can be customized). The RTS300R47K3.81A connects to the port (4) on the controller.

3)USB to RS485 converter cable(Model:CC-USB-RS485-150U-3.81)



It used to monitor each controller on the network via PC software. The length of cable is 1.5m. one end connect the (8) port of controller, the other end connect the PC

4)WIFI Serial Adapter(Model:eBox-WIFI-01)



After the controller is connected with the eBox-WIFI-01 through the standard Ethernet cable(parallel cable), the operating status and related parameters of the controller can be monitored by the mobile APP through WIFI signals.

5) RS485 to bluetooth adapter(Model:eBox-BLE-01)



After the controller is connected with the eBox-BLE-01 through the standard Ethernet cable(parallel cable), the operating status and related parameters of the controller can be monitored by the mobile APP through Bluetooth signals.

6) AES adapter(Model: AES-ADP)



The adapter converts 5V of controller into 12V of the refrigerator, it will supply the surplus solar power to the refrigerator to avoid energy waste.

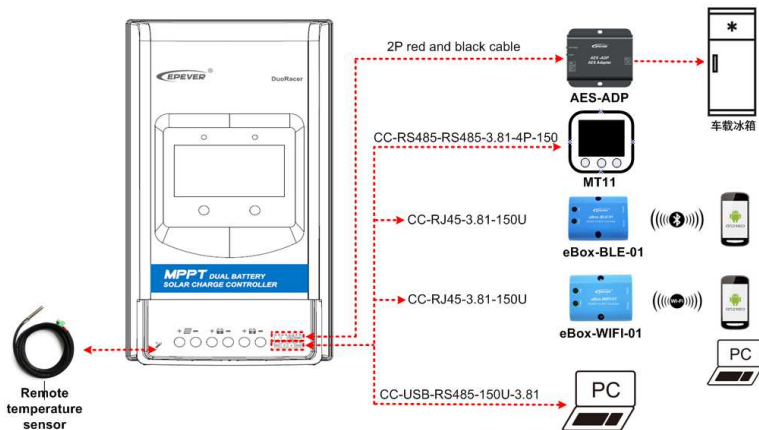

2. Installation

2.1 Warning

- Be very careful when installing the batteries, especially flooded lead-acid battery. Please wear eye protection, and have fresh water available to rinse if any contact with battery acid.
- Keep the battery away from any metal objects, which may cause short circuit of the battery.
- Explosive battery gases may come out from the battery during charging, so make sure ventilation condition is good.
- For outdoor installation, keep out of the direct sunshine and rain infiltration.
- Loose connections and corroded wires may result in high heat that can melt wire insulation, burn surrounding materials, or even cause fire. Ensure tight connections and use cable clamps to secure cables and prevent them from swaying in mobile application.
- The controller can work with lead-acid battery and lithium battery within its control scope.
- Battery connection may be wired to one battery or a bank of batteries. The following instructions refer to a singular battery, but it is implied that the battery connection can be made to either one battery or a group of battery bank.
- Select the system connection cables according to the current density no greater than $5A/mm^2$.

2.2PV Array Requirements

(1)Serial connection(string) of PV modules

As the core component of solar system, controller could be suitable for various types of PV modules and maximize converting solar energy into electrical energy. According to the open circuit voltage(Voc) and the maximum power point voltage(Vmpp) of the MPPT controller, the series number of different types PV modules can be calculated.

The below table is for reference only.

DR1106/2106/3106/1206/2206/3206N-DDB/DDS:

System voltage	36cell Voc<23V		48cell Voc<31V		54cell Voc<34V		60cell Voc<38V	
	Max.	Best	Max.	Best	Max.	Best	Max.	Best
12V	2	2	1	1	1	1	1	1
24V	2	2	-	-	-	-	-	-

System voltage	72cell Voc<46V		96cell Voc<62V		Thin-Film module Voc>80V
	Max.	Best	Max.	Best	
12V	1	1	-	-	-
24V	1	1	-	-	-

NOTE: The above parameter values are calculated under standard test conditions (STC(Standard Test Condition): Irradiance 1000W/m², Module Temperature 25 °C, Air Mass 1.5.)

DR2210/3210N-DDB/DDS:

System voltage	36cell Voc<23V		48cell Voc<31V		54cell Voc<34V		60cell Voc<38V	
	Max.	Best	Max.	Best	Max.	Best	Max.	Best
12V	4	2	2	1	2	1	2	1
24V	4	3	2	2	2	2	2	2

System voltage	72cell Voc<46V		96cell Voc<62V		Thin-Film module Voc>80V
	Max.	Best	Max.	Best	
12V	2	1	1	1	1
24V	2	1	1	1	1

NOTE: The above parameter values are calculated under standard test conditions (STC(Standard Test Condition): Irradiance 1000W/m², Module Temperature 25 °C, Air Mass 1.5.)

(2)Maximum PV array power

The MPPT controller has the function of charging current/power-limiting, that is, during the charging process, when the charging current or power exceeds the rated charging current or power, the controller will automatically limit the charging current or power to the rated value, which can effectively protect the charging parts of the controller, and prevent damages to the controller due to the connection of over-specification PV modules. The actual operation of PV array is as follows:

Condition1,

Actual charging power of PV array \leq Rated charging power of controller

Condition2,

Actual charging power of PV array \leq Rated charging power of controller

When the controller operates under“Condition1” or “Condition2”, it will carry out the charging as per the actual current or power; at this time, the controller can work at the maximum power point of PV array.



WARNING: When the power of PV is not greater than the rated charging power, but the maximum open-circuit voltage of PV array is more than

60V(DR**06N-DDB/DDS)/100V(DR**10N-DDB/DDS)(at the lowest environmental temperature), the controller may be damaged.

Condition3,

Actual charging power of PV array > Rated charging power of controller

Condition4,

Actual charging power of PV array > Rate charging current of controller

When the controller operates under“Condition 3” or “Condition 4”, it will carry out the charging as per the rated current or power.



WARNING: When the power of PV is not greater than the rated charging power, but the maximum open-circuit voltage of PV array is more than 60V(DR**06N-DDB/DDS)/100V(DR**10N-DDB/DDS)(at the lowest environmental temperature), the controller may be damaged.

According to “Peak Sun Hours diagram”, if the power of PV array exceeds the rated charging power of controller, then the charging time as per the rated power will be prolonged, so that more energy can be obtained for charging the battery. However, in the practical application, the maximum power of PV array shall be not greater than 1.5 times the rated charging power of controller. If the maximum power of PV array exceeds the rated charging power of controller too much, it will not only cause the waste of PV modules, but also increase the open-circuit voltage of PV array due to the influence of environmental temperature, which may make the probability of damage to the controller rise. Therefore, it is very important to configure the system reasonably. For the recommended maximum power of PV array for this controller, please refer to the table below:

Model	Rated Charge Current	Rated Charge Power	Max. PV Array Power	Max. PV Open Circuit Voltage
DR1106N-DDB/DDS	10A	130W/12V	195W/12V	46V ^① 60V ^②
DR2106N-DDB/DDS	20A	260W/12V	390W/12V	
DR3106N-DDB/DDS	30A	390W/12V	580W/12V	
DR1206N-DDB/DDS	10A	130W/12V 260W/24V	195W/12V 390W/24V	46V ^① 60V ^②
DR2206N-DDB/DDS	20A	260W/12V 520W/24V	390W/12V 780W/24V	
DR3206N-DDB/DDS	30A	390W/12V 780W/24V	580W/12V 1170W/24V	
DR2210N-DDB/DDS	20A	260W/12V 520W/24V	390W/12V 780W/24V	92V ^① 100V ^②
DR3210N-DDB/DDS	30A	390W/12V 780W/24V	580W/12V 1170W/24V	

①At 25℃ environment temperature.

②At minimum operating environment temperature.

2.3 Wire Size

The wiring and installation methods must conform to all national and local electrical code requirements.

➤ PV Wire Size

Since PV array output can vary due to the PV module size, connection method or sunlight angle, the minimum wire size can be calculated by the $I_{sc} \times$ of PV array. Please refer to the value of I_{sc} in the PV module specification. When PV modules are connected in series, the I_{sc} is equal to I_{sc} of PV modules. When PV modules are connected in parallel, the I_{sc} is equal to the sum of the PV modules' I_{sc} . The I_{sc} of the PV array must not exceed the controller's maximum PV input current. Please refer to the table as below:

NOTE: All PV modules in a given array are assumed to be identical.

* I_{sc} =Short circuit current(amps) V_{oc} = Open circuit voltage

Model	Max. PV input current	Max. PV wire size
DR1106N-DDB/DDS DR1206N-DDB/DDS	10A	4mm ² /12AWG
DR2106N-DDB/DDS DR2206N-DDB/DDS DR2210N-DDB/DDS	20A	6mm ² /10AWG
DR3106N-DDB/DDS DR3206N-DDB/DDS DR3210N-DDB/DDS	30A	10mm ² /8AWG



CAUTION: When the PV modules connect in series, the open circuit voltage of the PV array must not exceed 46V(DR06N-DDB/DDS),92V (DR**10N-DDB/DDS).**

➤ Battery and load wire size

The battery and load wire size must conform to the rated current, the reference size as below:

Model	Rated Charge Current	Battery wire size
DR1106N-DDB/DDS DR1206N-DDB/DDS	10A	4mm ² /12AWG
DR2106N-DDB/DDS DR2206N-DDB/DDS DR2210N-DDB/DDS	20A	6mm ² /10AWG
DR3106N-DDB/DDS DR3206N-DDB/DDS DR3210N-DDB/DDS	30A	10mm ² /8AWG

 **CAUTION:** The wire size is only for reference. If there is a long distance between the PV array and the controller or between the controller and the battery. Larger size wires can be used to reduce the voltage drop and improve performance.

 **CAUTION:** For the battery, the recommended wire size will be selected according to the conditions that its terminals are not connected to any additional inverter.

2.4 Mounting

 **WARNING:** Risk of explosion. Never install the controller in a sealed enclosure with flooded batteries. Do not install in a confined area where battery gas can accumulate.

 **WARNING:** Risk of electric shock. When wiring the solar modules, the PV array can produce a high open circuit voltage, so turn off the breaker before wiring and be careful when wiring.

 **CAUTION:** The controller requires at least 150mm of clearance above and below for proper air flow. Ventilation is highly recommended if mounted in an enclosure.

Installation steps:

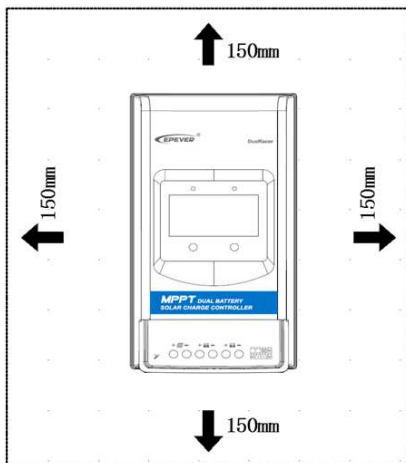

Step1: Determine of installation location and heat-dissipation space



Determination of installation location: The controller shall be installed in a place with sufficient air flow through the radiators of the controller and minimum clearance of 150mm from the upper and lower edges to ensure natural thermal convection.

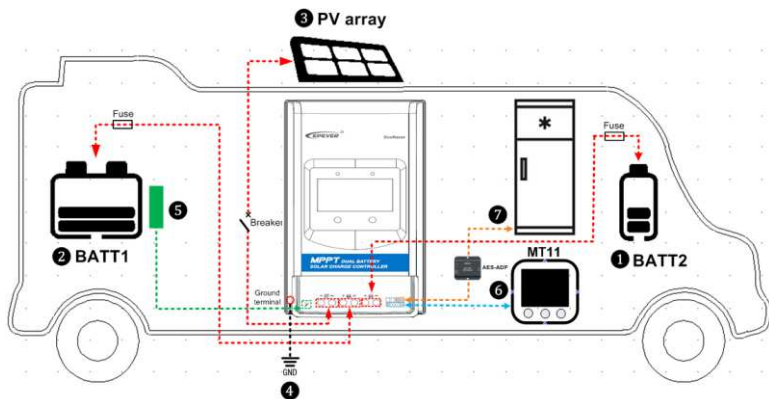

CAUTION: Ensure that the controller is able to dissipate heat if it's installed in a closed area. If the controller is to be installed in an enclosed box, it is important to ensure reliable heat dissipation through the box.



Step2: Wiring ①②③

Connect the system in the order of ① Starter battery BATT2  → ② Main battery BATT1  → ③ PV array  in accordance with the above diagram and disconnect the system in the reverse order ③ ② ①.



CAUTION: The BATT1 and BATT2 must be set at same voltage level, and other situations are not supported for the moment.



CAUTION: Follow the above instruction for wiring, otherwise, it may cause the BATT2 system voltage identification error.



CAUTION: While wiring the controller do not turn on the breaker or fuse and make sure that the poles of “+” and “-” are connected correctly.



CAUTION: A fuse which current is 1.25 to 2 times the rated current of the controller must be installed on the battery side with a distance from the battery not greater than 150mm



CAUTION: If an inverter is to be connected to the system, connect the inverter directly to the battery.

Step3: Grounding ④

DR N series is a common-negative controller, where all the negative terminals of PV array and battery can be grounded simultaneously or any one of the negative will be grounded. However, according to the practical application, all the negative terminals of PV array and battery needn't to be grounded, but the grounding terminal on controller's shell must be grounded, which may effectively shield the electromagnetic interference from the outside, and prevent some electric shock to the human body due to the electrification of the shell.



CAUTION:For common-negative systems, such as a motorhome, it is recommended to use a common-negative controller, but if in the common-negative system, some common-negative equipment is used, and the positive electrode is grounded, the controller may be damaged.

Step4: Connect the remote temperature sensor cable ⑤



Temperature sensor
(Model:RT-MF58R47K3.81A)



Remoter temperature sensor
(Model:RTS300R47K3.81A)

Connect the remote temperature sensor cable to the port ④ and place the other end close to the BATT1.



CAUTION: If the remote temperature sensor is not connected to the controller, the default temperature for battery charging or discharging is 25℃ without temperature compensation.

Step5: Connect the remote meter MT11 ⑥ and AES signal of the refrigerator ⑦ DR1106/2106/3106N-DDB/DDS:

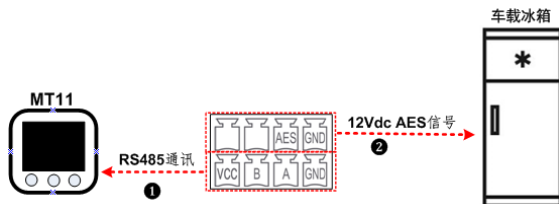

DR1206/2206/3206/2210/3210N-DDB/DDS:

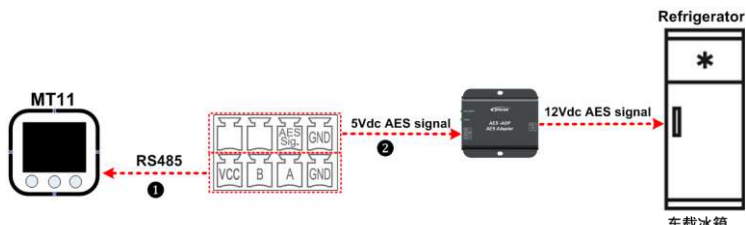

① RS485 Communication cable

Models: CC-RS485-RS485-3.81-4P-150(Included)

CC-RS485-RS485-3.81-4P-1000(Optional)

CC-RS485-RS485-3.81-4P-2000(Optional)

The operation of the remote meter refer to the user manual of MT11

The controller only provides one AES signal control, and the practical consideration is needed for the specific application (Check the "1.5 AES Signal output port instruction" for more information).

Step6: Power on the controller

Firstly, turn on the BATT2 safety switch and check the BATT2 charging indicator status. then, turn on the BATT1 safety switch and check the BATT1 charging indicator status (Check the "3. Display Units" for more information). Lastly, turn on the PV array circuit breaker.





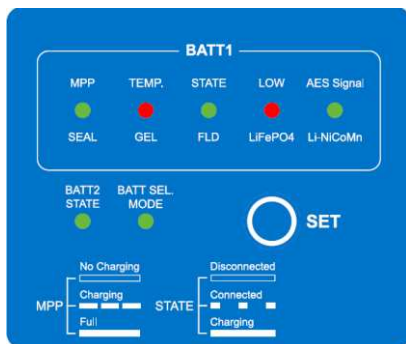

CAUTION: If the controller is not operating properly or the battery indicator on the controller shows abnormality, please refer to 5.2 "Troubleshooting".

3.Display units

3.1 DuoRacerDisplay Basic (DDB)



(1) Status indicator

indicator	Color	Status	Instruction
	Green	OFF	No charging
	Green	Slowly flashing (1Hz)	Charging, in Boost or Equalize charging stage
	Green	On solid	Full, in Float charging stage
	Red	OFF	BATT1 Temperature normal
	Red	Fast flashing (4Hz)	BATT1 over temperature or BATT1 low temperature
	Green	On solid	Connect to BATT1 and in charging
	Green	Slowly flashing (0.2Hz)	Connect to BATT1 and no charging
	Green	OFF	Not connect BATT1
	Red	On solid	BATT1 over discharged/Low voltage
	Red	OFF	BATT1 low voltage reconnect
	Green	On solid	AES signal is ON
	Green	OFF	AES signal is OFF
	Green	On solid	Connect to BATT2 and in charging
	Green	Slowly flashing(1Hz)	Connect to BATT2 and no charging

	Green	OFF	Not connect BATT2
	Green	On solid	In the mode of setting battery type
	Green	OFF	Settings are saved and quit the setting mode
All indicator		Fast flashing(4Hz)	System voltage error ^①
All indicator		Slowly flashing(1Hz)	Controller overheating





①The controller don't recognize the syetem voltage when the battery type is lithium battery

 Indicator "OFF".  Indicator "On solid".

 Indicator "Slowly flashing (1Hz)".

 Indicator "Slowly flashing (0.2Hz)".

(2) Battery type indicator

Indicator	Color	Status	Instruction
 SEAL Sealed	Green	On solid	12V system
		Flashing	24V system
 GEL Gel	Red	On solid	12V system
		Flashing	24V system
 FLD Flooded	Green	On solid	12V system
		Flashing	24V system
 LiFePO4 LiFePO ₄	Red	On solid	12V system
		Flashing	24V system
 Li-NiCoMn Li-NiCoMn	Green	On solid	12V system
		Flashing	24V system

The step of setting battery type:

Step1: Press the button and hold on 3s,  green on solid, enter the battery setting mode.

Step2: Press the button to select the battery type.

Step3: Wait for 5 seconds until the setting indicator turns off. Battery type is set successfully.



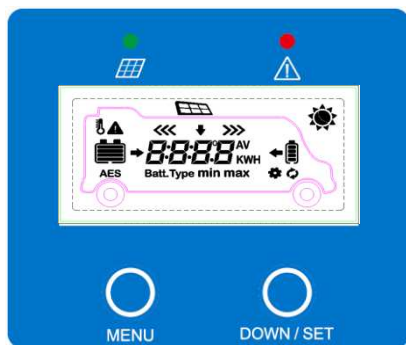





3.2 DuoRacerDisplay Standard (DDS)

















(1)Charging indicator

Indicator	Color	Status	Instruction
	Green	On solid	PV connection normal but the low voltage(low irradiance) from PV, no charging.
	Green	OFF	No PV voltage(night time) or PV connection problem
	Green	Slowly flashing(1Hz)	In charging
	Green	Fast flashing(4Hz)	PV overvoltage









(2)Operation interface

Icon	Instruction	Icon	Instruction
	BATT1 battery capacity [Ⓞ] 0~12%		BATT2battery capacity [Ⓞ] 0~12%
	BATT1battery capacity [Ⓞ] 13%~35%		BATT2battery capacity [Ⓞ] 13%~35%
	BATT1battery capacity [Ⓞ] 36%~61%		BATT2battery capacity [Ⓞ] 36%~61%
	BATT1battery capacity [Ⓞ] 62%~86%		BATT2battery capacity [Ⓞ] 62%~86%

	BATT1battery capacity [Ⓞ] 87%~100%		BATT2battery capacity [Ⓞ] 87%~100%
	Day		PV array
	Night		BATT1 charging icon
	Display the parameters of PV		BATT2charging icon
	Display the parameters of BATT1		BATT1temperature parameters
	Display the parameters of BATT2	AES	AES signal icon
	Setting icon	Batt.Type	Battery type icon
	Auto global browsing icon	min	Minimum voltage icon
	Fault Icon	max	Maximum voltage icon



① Battery capacity is calculated by the linear relationship between the LVD voltage and float charging voltage.

Fault indication

Fault	Fault indicator	Charge indicator	LCD	Instruction
BATT1 overvoltage	Red Fast flashing	—	 	Battery capacity shows full, battery frame blink, fault icon blink.
BATT1 over-discharged	—	—	 	Battery capacity shows empty, battery frame blink, fault icon blink.
BATT1 over temperature	Red Fast flashing	—	 	Battery frame blink, fault icon blink, the temperature icon blink.
BATT1 system voltage error [Ⓞ]	Red Fast flashing	Green Fast flashing	 	Battery capacity shows empty, battery frame blink. Fault icon blinks and battery frame blink



① No alarm for system voltage error when BATT1 is lithium battery.

(3)Buttons

	Press the button	Parameters of PV array Parameters of BATT1 Parameters of BATT2 Auto global browsing mode (<i>Auto</i>)
	Press the button	Browse the parameters of PV array Browse the parameters of BATT1 Browse the parameters of BATT2
	Press the button and hold on 5s	Select the temperature unit Select the battery type

(1)Auto global browsing mode

Operation:

Press the  button until *Auto* appears. Then Press the  button,  appears. Now it is set as auto global browsing mode.

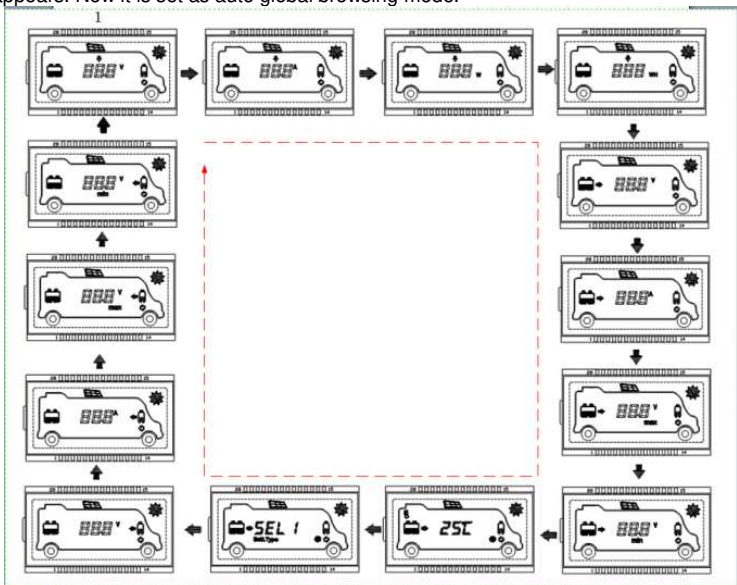

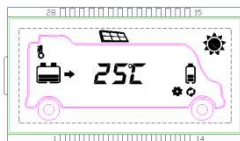

Loop display: PV voltage → PV current → PV power → Generated energy → BATT1 voltage → BATT1 current → Max. BATT1 voltage → Min. BATT1 voltage → BATT1 temperature → BATT1 battery type → BATT2 voltage → BATT2 current → Max. BATT2 voltage → Min. BATT2 voltage → PV voltage

(2)Change Temperature units



Operation:



Step1: Press the  button under the battery temperature interface, until the symbol is flashing.

Step2: Press the  button to select the temperature unit.

Step3: Press the  button to set successfully.

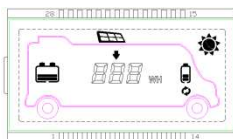
(3) Clear the generated energy



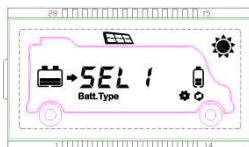

Press the  and  button at the same time and hold on for 5s to clear the generated energy.

(3)Change Battery type



1)Operation:

Step1: Press the  button and hold on for 5s under the battery type interface. until the symbol is flashing.

Step2: Press the  button to select the battery type.

Step3: Press the  button to confirm the battery type.

2) Battery type

SEL 1	BATT112V Sealed	SEL 2	BATT124V Sealed
GEL 1	BATT112V Gel	GEL 2	BATT124V Gel

FLd1	BATT112V Flooded	FLd2	BATT124V Flooded
LIF4	LiFePO ₄ (4S)	LIF8	LiFePO ₄ (8S)
LIC3	Li-NiCoMn (3S)	LIC6	Li-NiCoMn (6S)
USE	User		



CAUTION:The battery control voltage parameters are not changeable when battery is set as default battery types. If you want to change the control parameters, please set the battery type as "User".



CAUTION: The control parameters of user battery type can only be set via PC software or mobile APP.

1) Lead-acid Battery Control Voltage Parameters

The parameters are in 12V system at 25 °C, please double the values in 24V system.

Battery type Voltage parameter	Sealed	Gel	Flooded	User
Over Voltage Disconnect Voltage	16.0V	16.0V	16.0V	9~17V
Charging Limit Voltage	15.0V	15.0V	15.0V	9~17V
Over Voltage Reconnect Voltage	15.0V	15.0V	15.0V	9~17V
Equalize Charging Voltage	14.6V	—	14.8V	9~17V
Boost Charging Voltage	14.4V	14.2V	14.6V	9~17V
Float Charging Voltage	13.8V	13.8V	13.8V	9~17V
Boost Reconnect Charging Voltage	13.2V	13.2V	13.2V	9~17V
Low Voltage Reconnect Voltage	12.6V	12.6V	12.6V	9~17V
Under Voltage Warning Reconnect Voltage	12.2V	12.2V	12.2V	9~17V
Under Volt. Warning Volt.	12.0V	12.0V	12.0V	9~17V
Low Volt. Disconnect Volt.	11.1V	11.1V	11.1V	9~17V
Discharging Limit Voltage	10.6V	10.6V	10.6V	9~17V
Equalize Duration (min.)	120	—	120	0~180
Boost Duration (min.)	120	120	120	10~180

The following rules must be observed when modifying the parameters value in user battery type(factory default value is the same as sealed type):

- Over Voltage Disconnect Voltage > Charging Limit Voltage ≥ Equalize Charging Voltage ≥ Boost Charging Voltage ≥ Float Charging Voltage > Boost Reconnect Charging Voltage.
- Over Voltage Disconnect Voltage > Over Voltage Reconnect Voltage
- Low Voltage Reconnect Voltage > Low Voltage Disconnect Voltage ≥ Discharging Limit Voltage.
- Under Voltage Warning Reconnect Voltage > Under Voltage Warning Voltage ≥ Discharging Limit Voltage.
- Boost Reconnect Charging voltage > Low Voltage Reconnect Voltage.

1) Lithium Battery Control Voltage Parameters

The parameters are in 12V system at 25 °C, please double the values in 24V system.

Battery type Voltage parameter	LiFePO ₄ (4S)	Li-NiCoMn (3S)	User
Over Voltage Disconnect Voltage	15.6V	13.5V	9~17V
Charging Limit Voltage	14.6V	12.6V	9~17V
Over Voltage Reconnect Voltage	14.5V	12.5V	9~17V
Equalize Charging Voltage	14.5V	12.5V	9~17V
Boost Charging Voltage	14.5V	12.5V	9~17V
Float Charging Voltage	13.8V	12.2V	9~17V
Boost Reconnect Charging Voltage	13.2V	12.1V	9~17V
Low Voltage Reconnect Voltage	12.4V	10.5V	9~17V
Under Voltage Warning Reconnect Voltage	12.5V	11.0V	9~17V
Under Volt. Warning Volt.	12.0V	10.5V	9~17V
Low Volt. Disconnect Volt.	11.0V	9.3V	9~17V
Discharging Limit Voltage	10.8V	9.3V	9~17V

The following rules must be followed when modifying the value of lithium battery.

- A.** Over Voltage Disconnect Voltage > Over charging protection voltage (Protection Circuit Modules (BMS)) + 0.2V*;
- B.** Over Voltage Disconnect Voltage > Over Voltage Reconnect Voltage = Charging Limit Voltage ≥ Equalize Charging Voltage = Boost Charging Voltage ≥ Float Charging Voltage > Boost Reconnect Charging Voltage;
- C.** Low Voltage Reconnect Voltage > Low Voltage Disconnect Voltage ≥ Discharging Limit Voltage;
- D.** Under Voltage Warning Reconnect Voltage > Under Voltage Warning Voltage ≥ Discharging Limit Voltage;
- E.** Boost Reconnect Charging voltage > Low Voltage Reconnect Voltage;
- F.** Low Voltage Disconnect Voltage ≥ Over discharging protection voltage (BMS) + 0.2V*.



WARNING: The voltage parameters of lithium battery can be set, but you must refer to the voltage parameters of lithium battery BMS.



WARNING: The required accuracy of BMS shall be at least 0.2V. If the deviation is higher than 0.2V, the manufacturer will assume no liability for any system malfunction caused by this.













4. Protections, Troubleshooting & Maintenance

4.1 Protections

PV Over Current/Power	When the charging current or power of the PV array exceeds the controller's rated current or power, it will change at the rated current or power.
PV Short Circuit	When not in the PV charging state, the controller will not be damaged in case of a short-circuiting in PV array.
PV Reverse Polarity	When the polarity of the PV array is reversed, the controller may not be damaged and can continue to operate normally after the polarity is corrected. NOTE: If the PV array is reverse connected to the controller, 1.5 times rated controller power(watts) from the PV array, will damage the controller.
Night Reverse Charging	Prevents the battery from discharging to the PV module at night.
BATT1 and BATT2 Reverse Polarity	Fully protected against battery reverse polarity; no damage will occur to the battery. Correct the miswire to resume normal operation. NOTE: Limited to the characteristic of lithium battery, when the PV connection is correct either BATT1 or BATT2 battery connection reversed, the controller will be damaged.
BATT1 Over Voltage	When the battery voltage reaches the over voltage disconnect voltage, it will automatically stop battery charging to prevent battery damage caused by over-charging.
BATT1 Over Discharge	When the battery voltage reaches the low voltage disconnect voltage, it will automatically stop battery discharging to prevent battery damage caused by over-discharging. (Any controller connected loads will be disconnected. Loads directly connected to the battery will not be affected and may continue to discharge the battery.)
BATT1 Overheating	The controller can detect the battery temperature through an external temperature sensor. The controller stops working when its temperature exceeds 65 °C and restart to work when its temperature is below 55 °C.
BATT1 Low Temperature(Lithium Battery)	When the temperature detected by the optional temperature sensor is lower than the Low Temperature Protection Threshold(LTPT), the controller will stop charging and discharging automatically. When the detected temperature is higher than the LTPT, the controller will be working automatically (The LTPT is 0 °C by default and can be set within the range of 10 ~ -40 °C).
Controller Overheating	The controller is able to detect the temperature inside the controller. The controller stops working when its temperature exceeds 85 °C and restart to work when its temperature is below 75 °C.
TVS High Voltage Transients	The internal circuitry of the controller is designed with Transient Voltage Suppressors (TVS) which can only protect against high-voltage surge pulses with less energy. If the controller is to be used in an area with frequent lightning strikes, it is recommended to install an external surge arrester.

4.2 Troubleshooting

Faults phenomenon	Possible reasons	Troubleshooting
Charging LED indicator off during daytime when sunshine falls on PV modules properly	PV array disconnection	Confirm that PV wire connections are correct and tight.

Wire connection is correct,the controller is not working.	Battery voltage is lower than 8.5V	Please check the voltage of battery. At least 8.5V voltage to activate the controller.
DDS:  Red fast flashing   Battery level shows full, battery frame blink, fault icon blink	BATT1 over voltage	Check if battery voltage is higher than OVD(over voltage disconnect voltage), and disconnect the PV.
DDB:  red on solid DDS:   Battery level shows empty, battery frame blink, fault icon	BATT1 over discharged	When the battery voltage is restored to or above LVR(low voltage reconnect voltage), the load will recover
DDB:  Red fast flashing DDS:   Battery level shows current capacity, battery frame blink, fault icon blink, the temperature icon blink	BATT1 Overheating	The controller will automatically turn the system off. When the temperature declines to be below 55 °C, the controller will resume.
DDS:  RedFast flashing and  GreenFast flashing  	BATT1 System voltage error	①Check whether the battery voltage match with the controller working voltage. ②Please change to a suitable battery or reset the working voltage.
①System alarm system voltage error when using Lead-acid battery ②System alarm an over discharge fault when the ③BATT1 is 12V but set as 24V System alarm an over-voltage fault when BATT1 is 24V but set as 12V	Incorrect wiring steps should not connect BATT1 first and then BATT2	①Disconnect the system, and reconnect the BATT2 first, then reconnect BATT1 ②BATT1 voltage level should be the same as BATT2

4.3 Maintenance

The following inspections and maintenance tasks are recommended at least two times per year for best controller performance.

- Make sure controller firmly installed in a clean and dry ambient.
- Make sure no block on air-flow around the controller. Clear up any dirt and fragments on radiator.

- Check all the naked wires to make sure insulation is not damaged for serious solarization, frictional wear, dryness, insects or rats etc. Repair or replace some wires if necessary.
- Tighten all the terminals. Inspect for loose, broken, or burnt wire connections.
- Check and confirm that LED or LCD is consistent with required. Pay attention to any troubleshooting or error indication .Take necessary corrective action.
- Confirm that all the system components are ground connected tightly and correctly.
- Confirm that all the terminals have no corrosion, insulation damaged, high temperature or burnt/discolored sign, tighten terminal screws to the suggested torque.
- Check for dirt, nesting insects and corrosion. If so, clear up in time.
- Check and confirm that lightning arrester is in good condition. Replace a new one in time to avoid damaging of the controller and even other equipments.



WARNING: Risk of electric shock!

Make sure that all the power is turned off before above operations, and then follow the corresponding inspections and operations.

5. Specifications

Electrical Parameters

Item	DR1106N -DDB/DDS	DR2106N -DDB/DDS	DR3106N -DDB/DDS	DR1206N -DDB/DDS	DR2206N -DDB/DDS	DR3206N -DDB/DDS	DR2210N -DDB/DDS	DR3210N -DDB/DDS
BATT1 rated voltage	12VDC			12/24VDC			12/24VDC	
BATT2 rated voltage	12VDC			12/24VDC 自动识别				
Rated Charge Current	10A	20A	30A	10A	20A	30A	20A	30A
Battery Input Voltage Range	8.5~16V			8.5~32V ^①				
Max. PV Open Circuit Voltage	60V ^② 46V ^③						100V ^② 92V ^③	
MPP Voltage Range	(Battery Voltage+2V)~36V						(Battery Voltage+2V)~72V	
Rated Charge Power	130W/12V	260W/12V	390W/12V	130W/12V 260W/24V	260W/12V 520W/24V	390W/12V 780W/24V	260W/12V 520W/24V	390W/12V 780W/24V
Max. conversion efficiency	97.4%	97.5%	98%	97.4%	97.5%	98%	97.5%	98%
Full load efficiency	97%	96%	96%	97%	96%	96%	96%	96%
Self-consumption	12mA/12V;4mA/12V (Low-power mode)			12mA/12V;8mA/24V 4mA/12V;3mA/24V(Low-power mode)			26mA/12V;15mA/24V 19mA/12V;10mA/24V (Low-power mode)	
Temperature compensate coefficient ^④	-3mV/°C/2V(default)							
Grounding	Common negative							
BATT2Full voltage	13.8V/12V			13.8V/12V; 27.6V/24V(default)				
BATT2 Charge return voltage	13V/12V			13V/12V; 26V/24V(default)				
AES signal port ^⑤	12VDC/Max.200mA(3.81-4P)			5VDC/Max.200mA(2*(3.81-4P))				
RS485 com. port ^⑥	5VDC/Max.200mA(3.81-4P)							
Com. baud rate ^⑦	115200(default)							
LCD backlight time ^⑧	60S(default)							

- ① **Warning:**When the lithium battery of 12V is used and the BMS is protected, the lithium battery voltage may increase up to 35V which may damage the load, so please consider the load's voltage.
- ② At minimum operating environment temperature.
- ③ At 25°C environment temperature.
- ④ The Temperature compensate coefficient is zero and not changeable when the life battery type is lithium battery.
- ⑤ AES port which output is 12V/200mA and RS485 Port which output is 5V/200mA are independent of DR1106/2106/3106N models, the AES port output voltage is the battery voltage. The above two ports of DR1206/2206/3206/2210/3210N models share the power of 5VDC/Max. 200mA
- ⑥ The communication baud rate can only be set via PC software.
- ⑦ The LCD backing time can only be set via PC software, setting range is 0~999S and the 0s means the LCD is on all the time.

Environmental Parameters

Item	DR1106/2106/1206/2206/2210N-DDB/DDS	DR3106/3206/3210N-DDB/DDS
Working environment temperature(100% input and output)	-20°C~+50°C (DDS) -30°C~+50°C (DDB)	-20°C~+45°C (DDS) -30°C~+45°C (DDB)
Storage temperature range	-30°C~+80°C	
Relative humidity	≤95%, N.C	
Enclosure	IP33 3-protection against solid objects: protected against solids objects over 2.5mm. 3-protected against sprays to 60° from the vertical.	
Pollution degree	PD2	

Mechanical Parameters

Item	DR1106/1206N-DDB/DDS	DR2106/2206/2210N-DDB/DDS	DR3106/3206/3210N-DDB/DDS
Dimension	227.2×143×58.1mm	243.7×158×63mm	247.2×165×68.5mm
Mounting dimension	160×134mm	180×149mm	180×156mm
Mounting hole size	φ5mm		
Terminal	12AWG/4mm ² (BATT1) 12AWG/4mm ² (BATT2)	6AWG/16mm ² (BATT1) 12AWG/4mm ² (BATT2)	6AWG/16mm ² (BATT1) 12AWG/4mm ² (BATT2)
Recommended cable size	12AWG/4mm ² (BATT1) 12AWG/4mm ² (BATT2)	10AWG/6mm ² (BATT1) 12AWG/4mm ² (BATT2)	8AWG/6mm ² (BATT1) 12AWG/4mm ² (BATT2)
Weight	0.8kg	1.1kg	1.4kg

Annex I Mechanical Dimension Diagram

DR1106/1206N-DDB/DDS (Unit: mm)

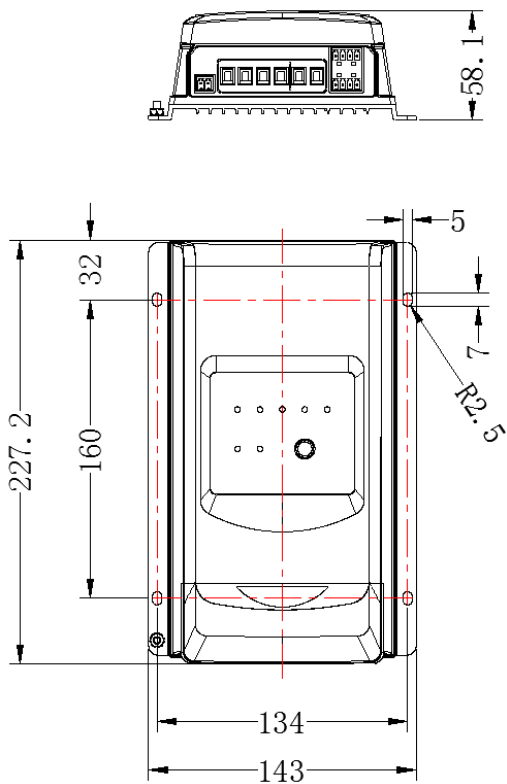

DR2106/2106/2206/2210N-DDB/DDS (Unit: mm)

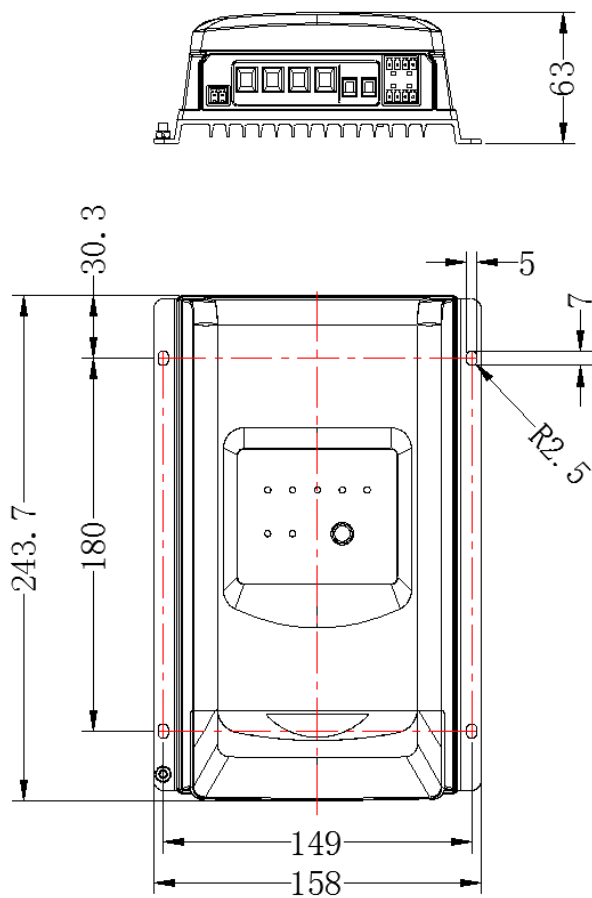

DR3106/3106/3206/3210N-DDB/DDS (Unit: mm)

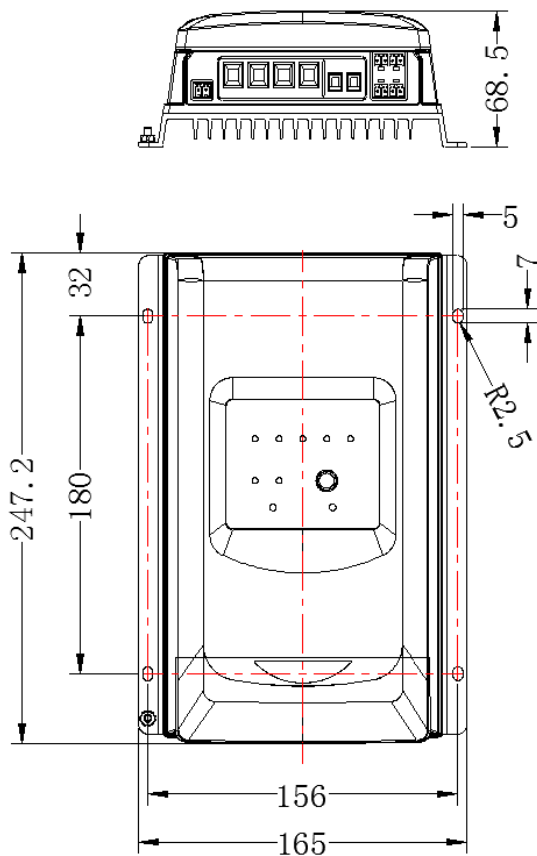

Any changes without prior notice!

Version number: 1.0



HUIZHOU EPEVER TECHNOLOGY CO., LTD.

Tel: +86-752-3889706

E-mail: info@epsolarpv.com

Website:<http://www.epsolarpv.com>